

MARSH SOUND DESIGN

O P E R A T I N G M A N U A L

Preamp lifier **P2000T**

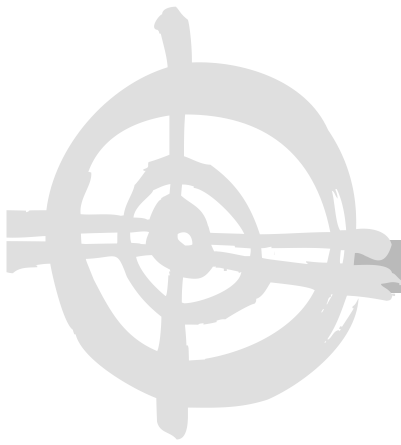

Warning

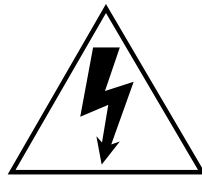

The lightning flash with arrowhead, within an equilateral triangle, is intended to alert the user to the presence of uninsulated “dangerous voltage” within the product’s enclosure that may be of sufficient magnitude to constitute a risk of electric shock to people.

CAUTION
RISK OF ELECTRIC SHOCK
DO NOT OPEN

CAUTION:

To prevent the risk of electric shock, do not remove the cover (or back) . No user-serviceable parts inside. Refer servicing to qualified service personnel.



The exclamation point within an equilateral triangle is intended to alert the user to the presence of important operating and maintenance instructions in the literature accompanying the appliance

WARNING: TO PREVENT FIRE OR SHOCK HAZARD, DO NOT OPEN OR EXPOSE THIS APPLIANCE TO RAIN OR MOISTURE.

Before proceeding with the installation, please read the instructions carefully and completely. If you have any problems, do not hesitate to contact your retailer or our Service Department.

- 1. All warnings on the unit and in the operating manual should be followed.**
- 2. Operate the unit only from a power source of the appropriate voltage indicated on the rear panel.**
- 3. Do not use a damaged or deformed power cord as it may cause electric shock. When removing the plug from the wall outlet, be sure to remove by holding the plug attachment and not by pulling the cord.**
- 4. This unit should not be used near water or in humid conditions.**
- 5. Do not pour or spill liquids of any kind onto this unit.**
- 6. Do not operate this product with any cover removed.**
- 7. Before connecting or disconnecting any cables, always turn off your equipment and disconnect your entire system from the AC mains.**
- 8. Do not replace any fuse with a value or type other than that specified.**
- 9. Do not overload the wall outlet or extension cord because this can result in a risk of fire or electric shock.**
- 10. Do not push objects of any kind into this product through the openings e.g., ventilation slots, because they may touch dangerous voltage points or short-out parts. This act could result in a fire or electric shock.**
- 11. Do not attempt to repair this product because opening or removing covers may expose you to dangerous voltage or other hazards. If a problem occurs, contact your Marsh retailer.**
- 12. Disconnect your entire system from the AC mains before cleaning.**
- 13. Slots and openings in the cabinet are provided for ventilation and to ensure reliable operation of this product and to protect it from overheating. These openings must not be blocked or covered.**
- 14. The operating temperature ranges from +5 to +35 degrees C. Operating humidity ranges from 5% to 80%. Do not operate the unit when the temperature and/or humidity are outside of this range.**

Thank You for purchasing the **MARSH SOUND DESIGN MSD-P2000T**.
MSD brings you extraordinary components that are true, above all, to the art of music.

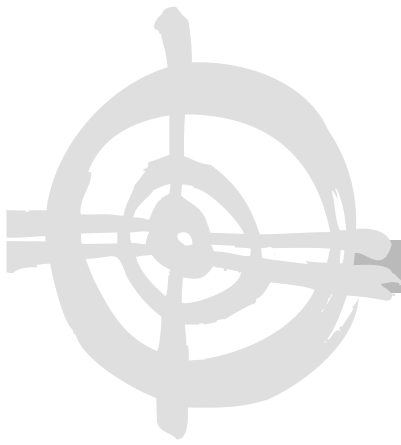

Table of Contents

Important/Precautions.....	2
Preface.....	6
Unpacking.....	8
Placement Considerations.....	9
Functions.....	10
Connections.....	11
Troubleshooting guide.....	12
Care & Maintenance.....	13
Warranty information.....	14
Specifications.....	15
Dimensions.....	16



MSD's logo comes from an ancient Native American petroglyph pecked in stone, high in the Sierra Nevada mountain range. Long ago, small, self-sufficient groups of people moved about the mountains, hunting and gathering, and celebrating rituals. Leaving behind little about themselves, except for these rock figures and a few stone tools. The mark we found, created a thousand years ago, could have been a sun sign, a map, or a symbol of focus and concentration-or yet some mystery we cannot imagine today.

Preface

Just as a great performer spends years learning his or her instruments, so a master designer spends years understanding the complexities of audio circuitry and the science of electronics.

For more than 30 years, *Richard N. Marsh*, author, lecturer, engineer, and inventor, has shared the art of perfecting audio circuits with other designers. Now, his goal is to bring you his accumulated experience in the service of music.

The Marsh Sound Design team builds its products to the most exacting standards of design and construction, for simplicity of use, long life and timeless performance. Your investment in a Marsh product means that you can forget about the hardware and focus on years of enjoyment.

So - set your course for the music . . .and leave the rest to us.

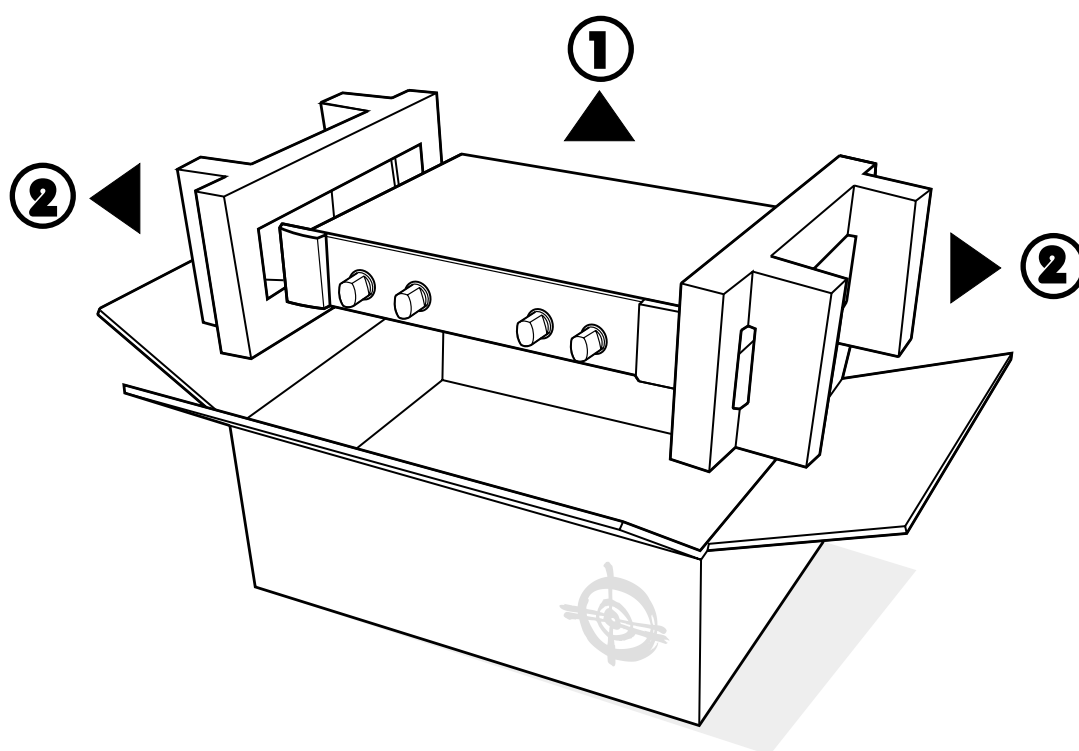

WARNING: PEOPLE WITH BACK PROBLEMS SHOULD NOT UNPACK THIS EQUIPMENT WITHOUT ASSISTANCE.

1. Carefully lift the unit out of the box.
2. Remove the foam packing material.
3. Set up the unit for use.

REMEMBER: *Keep all the original packing in case it is necessary to return the unit for servicing.*



Placement Considerations

DO NOT INSTALL THE UNIT IN THE FOLLOWING LOCATION:

1. In a place subject to direct sunlight.
2. In a humid place.
3. In an extremely hot or cold place.
4. In a place subject to vibrations.
5. In a dusty place.
6. In a poorly ventilated place.

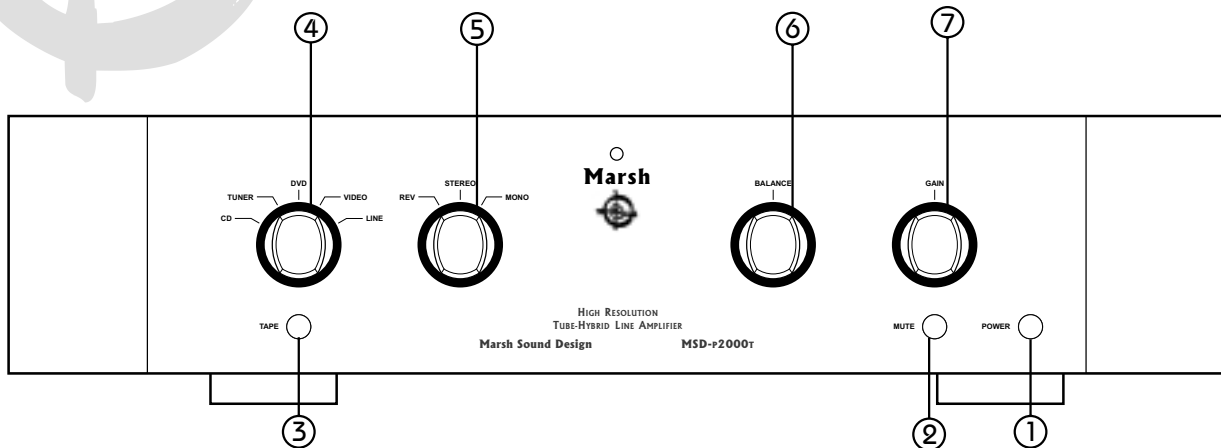

- 1. POWER** Press the **POWER** button to turn the unit ON. The LED will appear BLUE when the unit is ON. The MSD-P2000T will remain in a mute state for approximately 50 seconds after turning it on to allow for component stabilization. The vacuum tube requires this time to become operative. The power LED will be dimly lit while the unit is in a mute state. The LED will be fully lit when the unit is out of mute and ready to play.

Press **POWER** button again to turn the unit OFF. The LED will not be lit when the unit is switched off.
- 2. MUTE** Press the **MUTE** button to turn the sound off. Press the **MUTE** button again to resume sound.

***REMEMBER:** Every time the power is turned on, the unit will always start in a mute state.*
- 3. TAPE** Press the **TAPES** button to selector TAPE input as the source. Press TAPE button again to deactivate TAPE mode.
- 4. SELECTOR** Turn the select knob to the desired source input.
- 5. MODE** Normal operation is STEREO mode . If a source is mono sound, select MONO mode to ensure the usage of both speakers.

If you want to change the speaker output to the opposite of that in which the sound was recorded (from right to left and vice versa), select REVERSE mode. This is useful if the original recording was made improperly or to test the stereo system.
- 6. BALANCE** Turn the balance level knob to adjust the sound balance between the two speakers. Leave it in the center position to give equal output on both channels.

Sometimes in unequal source recording, you may need to adjust the balance level to get a balanced stereo sound. If the sound is weaker on left side, move the knob to left until you hear equal sound from both speakers and vice versa.
- 7. GAIN** Adjust the output level.

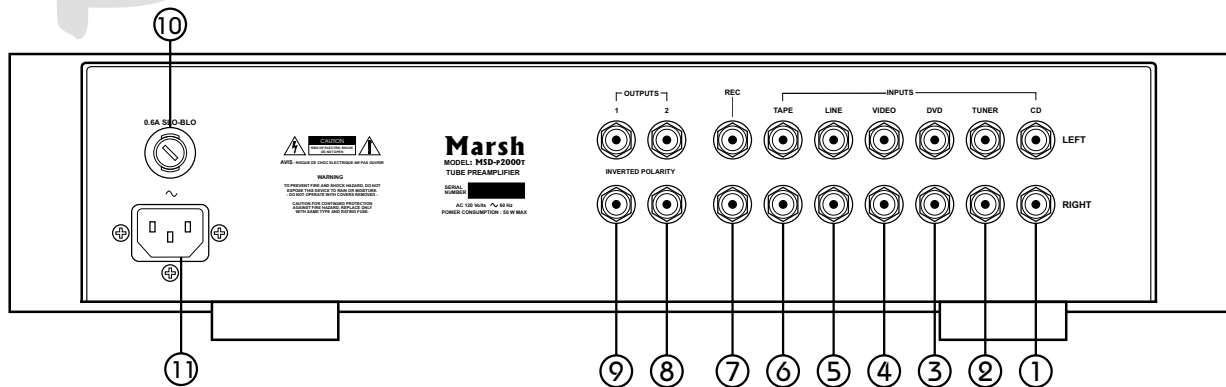

INPUTS The MSD-P2000T have a total of 6 line level inputs.

1. **CD** Receives signals from a Compact Disc player.
2. **TUNER** Receives signals from a Tuner.
3. **DVD** Receives signals from a Digital Versatile Disc player.
4. **VIDEO** Receives signals from a VCR audio outputs.
5. **LINE** Receives signals from a line level source.
6. **TAPE** Receives signals from a cassette tape player.

REC (Recording output monitor) The MSD-P2000T has a recording monitor output for duplication.

7. **TAPE (REC)** Sends output signals from a selected source to cassette tape input. To record from the program source onto cassette tape, turn the selector knob to the source program you wish to record and press record on cassette tape player.

OUTPUTS The MSD-P2000T has 2 outputs for connections to power amplifier.

8. **OUTPUT 2** Sends signals to a power amplifier (use in bi-amplifier application).
9. **OUTPUT 1** Sends signals to a power amplifier.

NOTE *The output signal is inverted polarity to the source signal, you may need to change the polarity of both left and right speakers cables to get the correct program polarity.*

10. **MAIN FUSE** If there is a problem with the original fuse, replace with a fuse of the same type and rating.
11. **POWER** Connect the MSD-P2000T to the outlet with the enclosed power cord.

IMPORTANT: *Operate the unit only from the power source of the appropriate voltage indicated on rear panel.*



If the unit does not function properly, please check the list below and follow the instructions. If the problem still occurs, please contact our service department.

PROBLEM	SOLUTION
1. Unit does not turn on. The LED is not lit.	Confirm that the power cord is plugged in properly. Check If the fuse is still good.
2. No sound.	Check the speaker cable connection. Check the interconnect cable connection.
3. No sound from one speaker.	Check the speaker or interconnect cable connection. Check the BALANCE control on the preamplifier, make sure that It is in the middle position. Check the MUTE switch.
4. Low bass sound.	Check the speaker cables for correct phase connection.



Care & Maintenance

Use a soft, dry cloth to remove dust from the cabinet. For stubborn dirt, soak the cloth in a weak detergent solution. Be sure to wring the cloth well before wiping the unit. Use a dry cloth to wipe it dry. Do not use any volatile agents such as benzine or thinner. They may damage the surface of the cabinet.

CAUTION: DISCONNECT YOUR ENTIRE SYSTEM FROM THE AC MAINS BEFORE CLEANING. NEVER APPLY LIQUID CLEANSERS DIRECTLY TO THE UNIT. IT MAY RESULT IN DAMAGE TO THE ELECTRONIC COMPONENTS WITHIN THE UNIT.

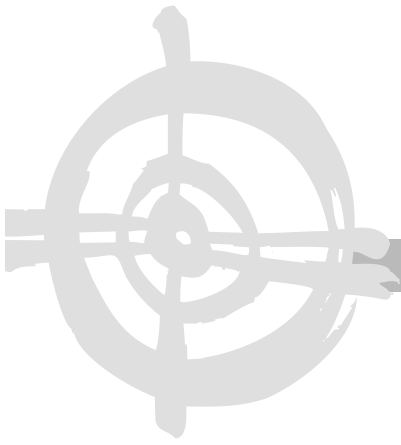

Warranty information

- 1. A MARSH SOUND DESIGN warranty only applies to the original retail purchaser. The warranty certifies that the product is free from defects in material and workmanship and authorizes free service and/or parts exchange for a period of TWO years from the date of purchase. Service must only be done at an authorized MARSH SOUND DESIGN Service center.**
- 2. The warranty is subjected to the following conditions and limitations. The warranty is void if the product has been used in a manner other than that specified within the operating manual, if the product has been abused or misused, or if the product has been repaired by anyone other than an authorized MASH SOUND DESIGN Service center.**
- 3. The warranty does not apply to defects or failure caused by usage of unauthorized parts, improper maintenance, fire, flood, lightning or other natural causes.**
- 4. This warranty does not cover damage to the external parts, e.g. Front panel, knobs, casing, etc.**
- 5. A returned product must include a copy of the Warranty Certificate and the bill of sale and must be sent in the original packaging.**
- 6. The warranty does not extend to any incidental or consequential cost or damage to the purchaser caused by a malfunction of the product.**

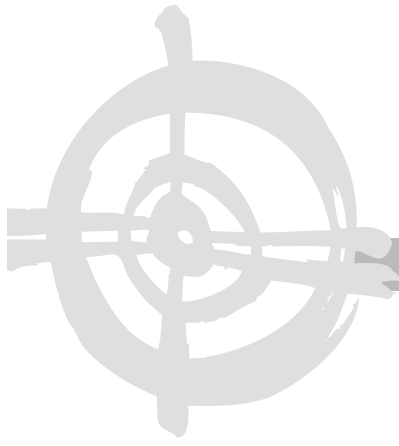

Specifications

Frequency Response, 20-20,000 Hz	+/- 0.1 dB
THD+ noise at 1 Vrms, 20-20,000 Hz	<0.05%
Input Impedance	50 kOhms
Maximum Gain	23 dB
Signal to Noise ratio, A weighted	90 dB
Maximum Output at 1kHz	8 Vrms
Crosstalk at 1 kHz	-90 dB
Crosstalk at 10 kHz	-90 dB
Input Power	AC 110-120 V, 60 Hz
Power consumption	30 W
Size	19" W x 4½" H x 13" D
Weight	Net 13 lbs (5.8 kgs), Shipping 16 lbs (7.2 kgs)



Dimensions P2000T

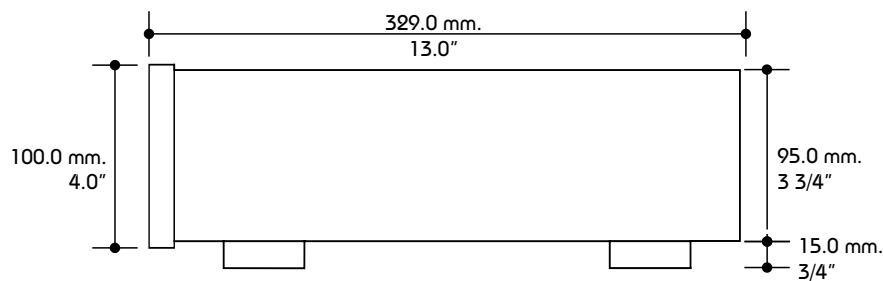
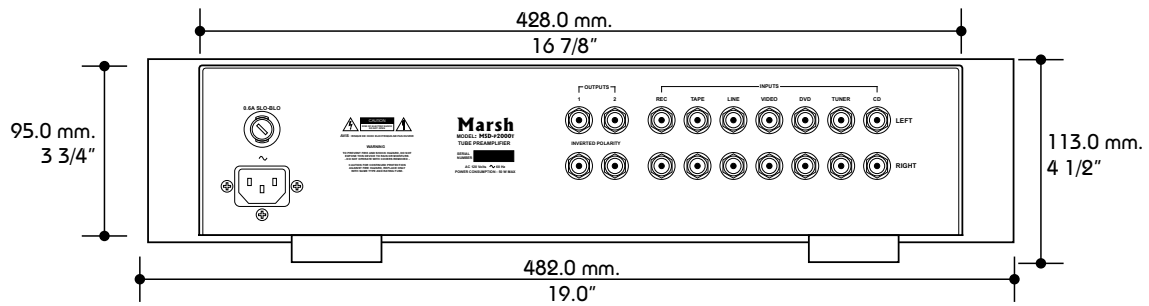
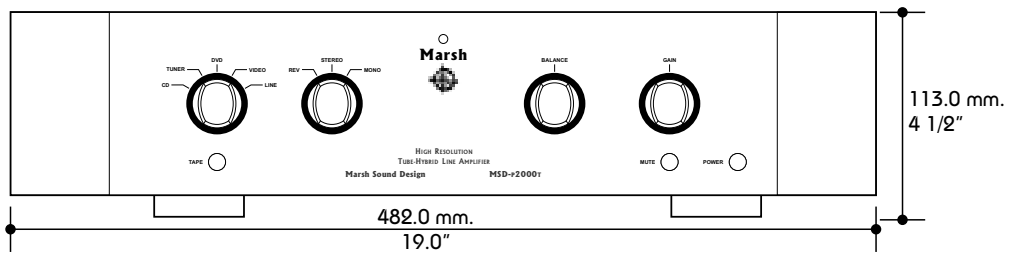



Marsh

MARSH SOUND DESIGN

Email: sales@marshsounddesign.com

www.marshsounddesign.com

Tel: (415) 927-4672 Fax: (415) 924-6846

62 El Camino Drive, Corte Madera, CA 94925